

Buiselementen buig vormen

La Grand
Elektrische Verwarmings
Onderneming
Rotterdam

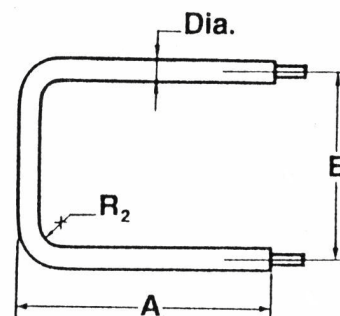
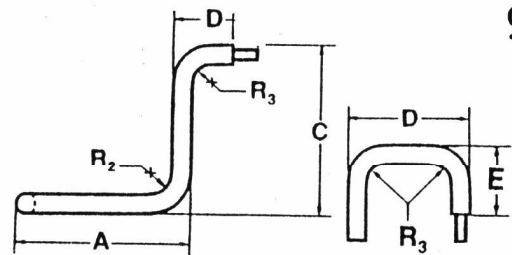
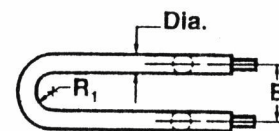
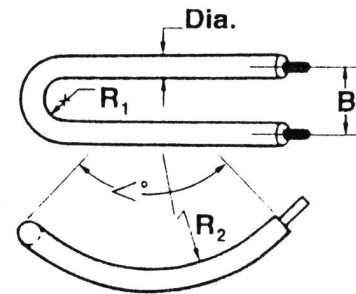
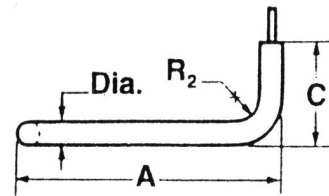
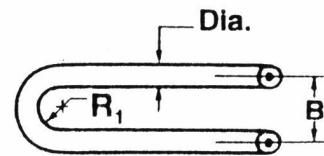
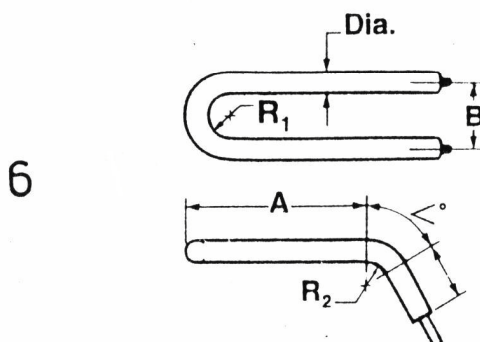
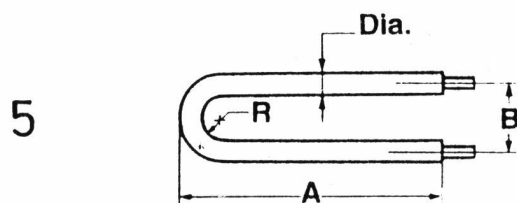
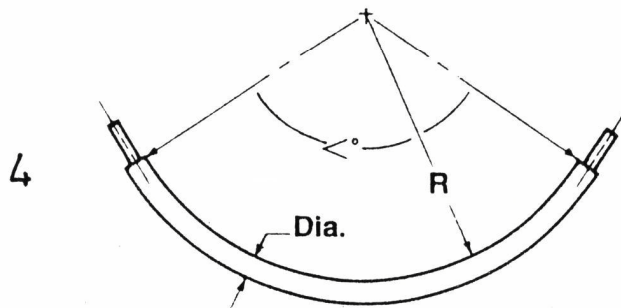
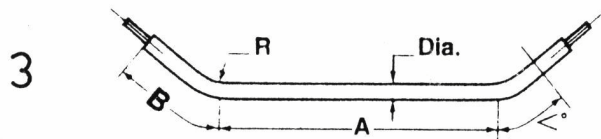
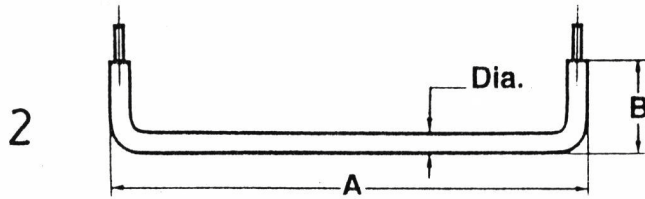
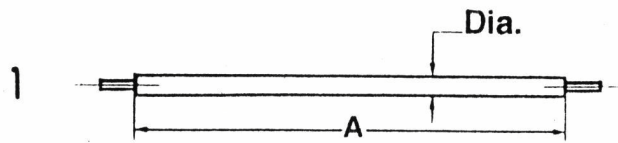

7

8

9

10

Buiselementen buig vormen

La Grand
Elektrische Verwarmings
Ondernemng
Rotterdam

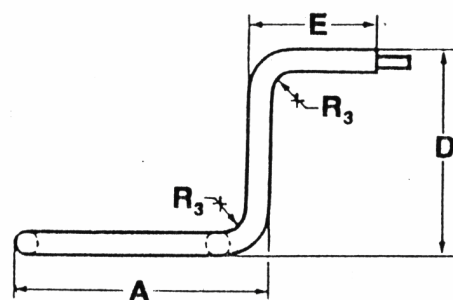
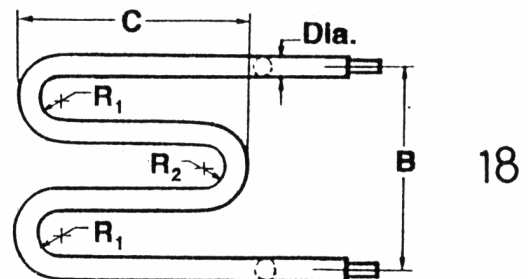
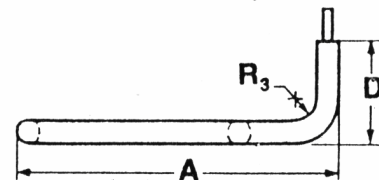
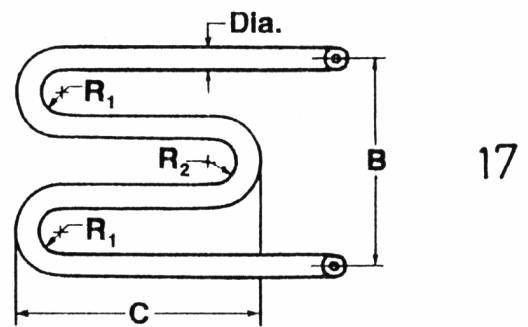
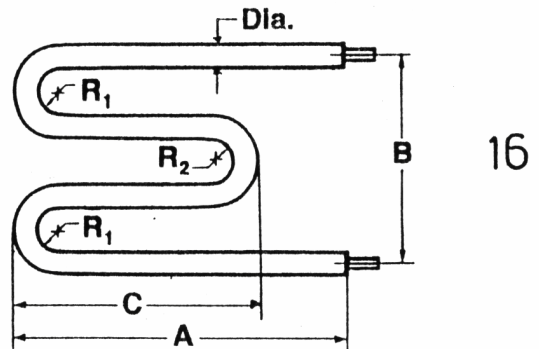
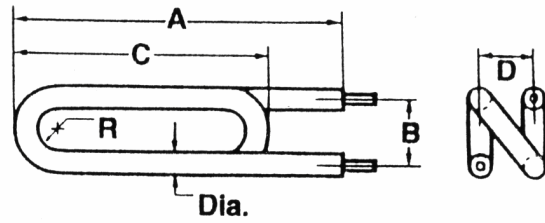
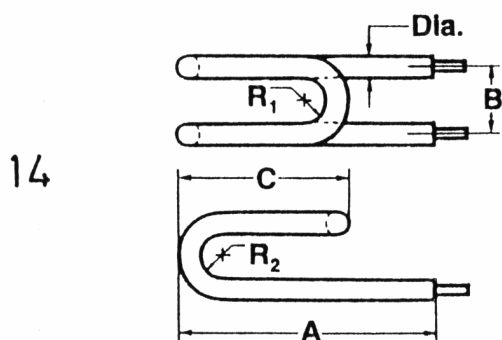
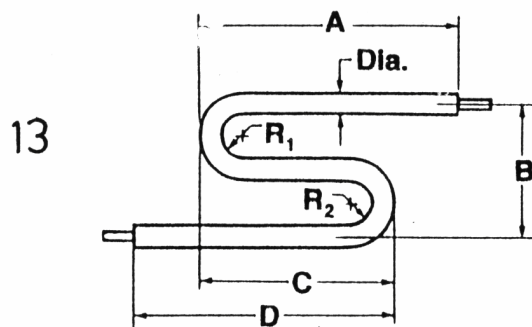
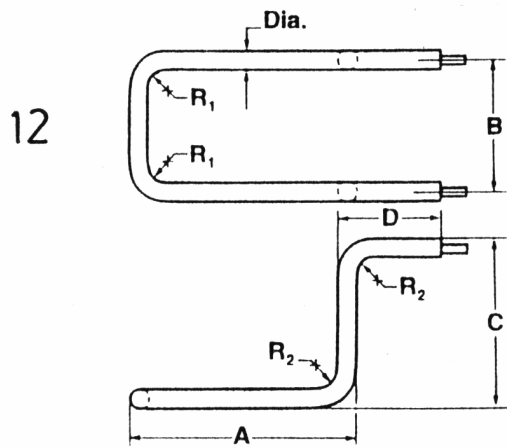
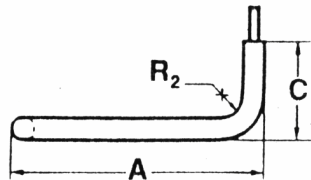
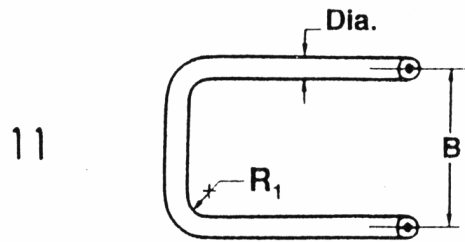

Buiselementen buig vormen

La Grand
Elektrische Verwarmings
Onderneming
Rotterdam

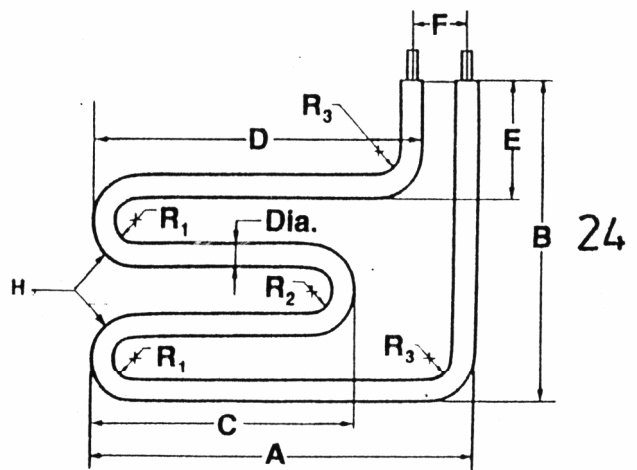
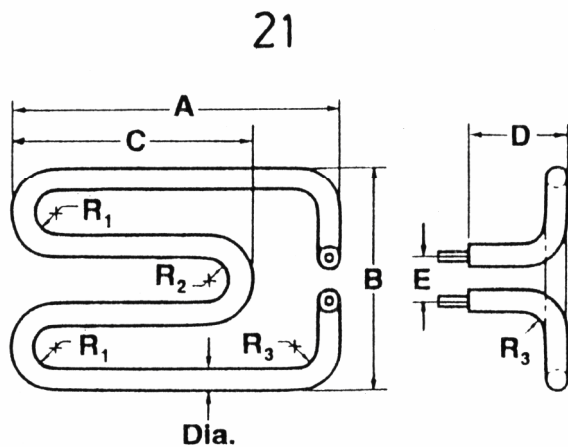
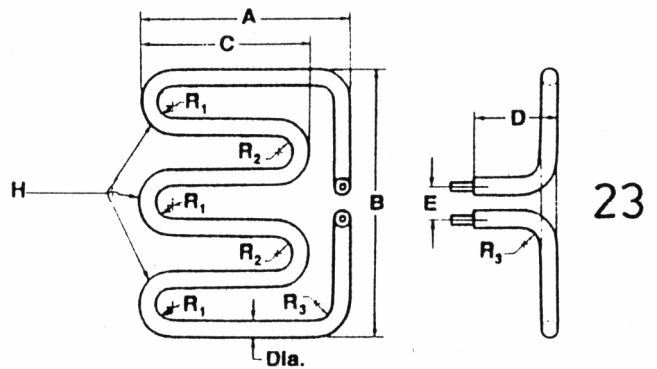
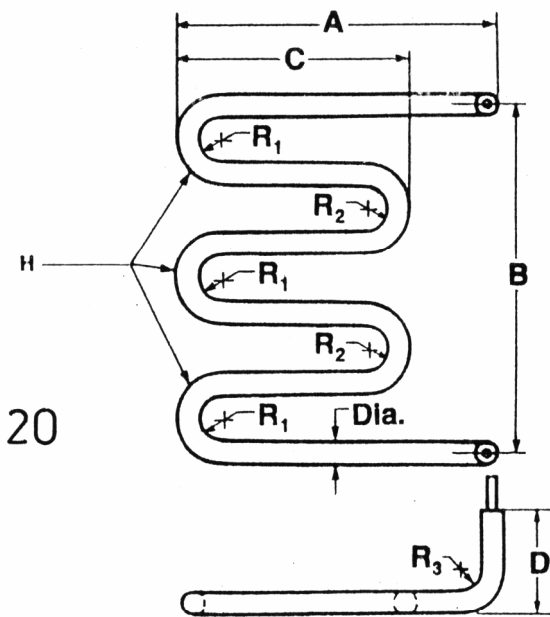
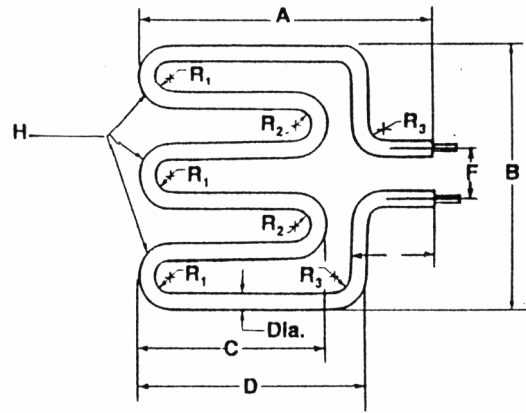
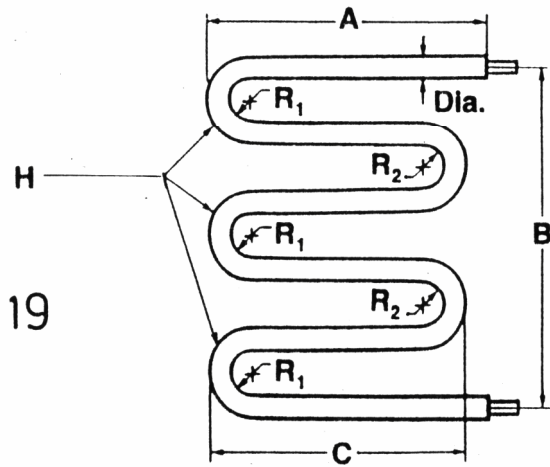

Buiselementen buig vormen

La Grand
Elektrische Verwarmings
Onderneming
Rotterdam

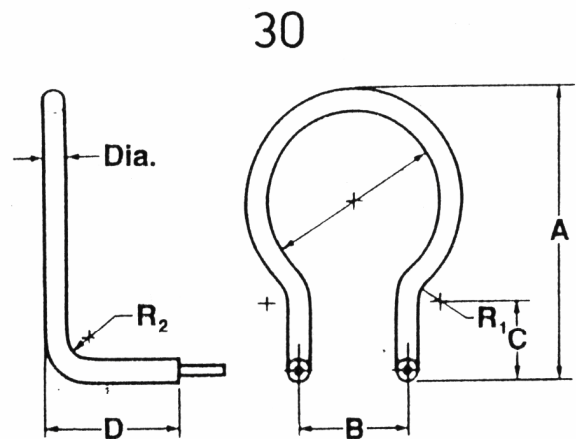
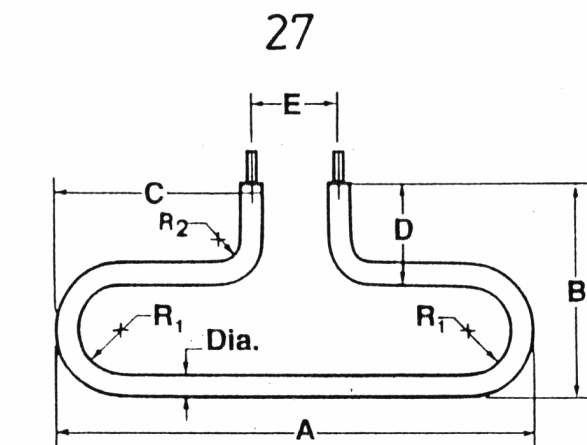
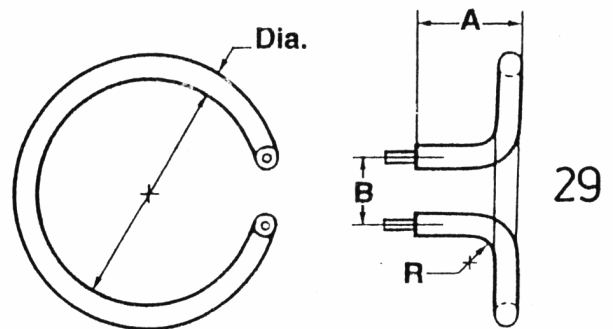
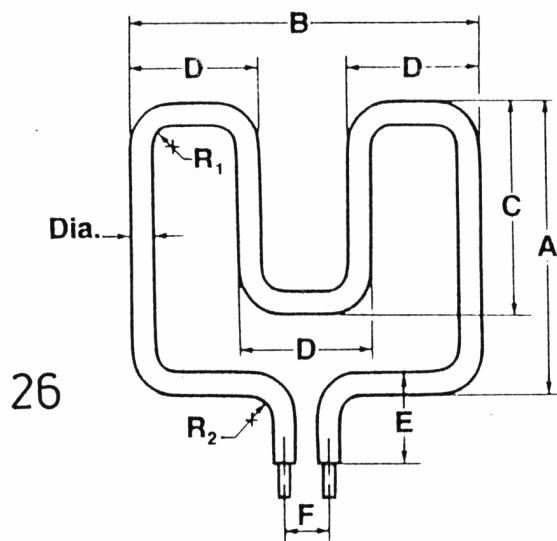
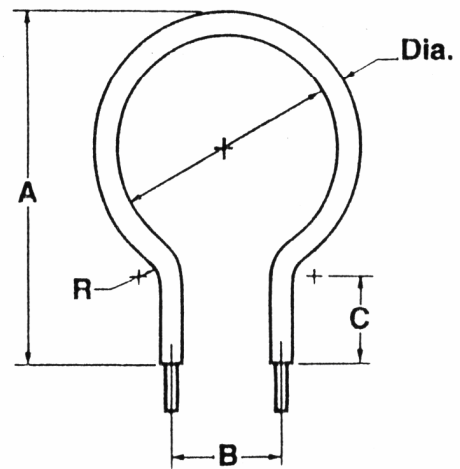
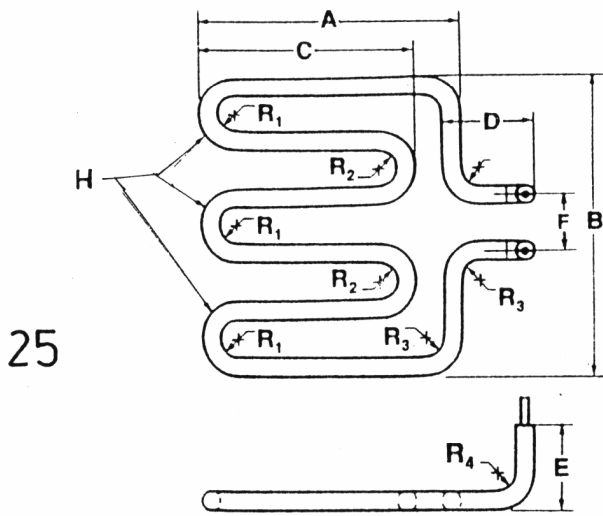

Buiselementen buig vormen

La Grand
Elektrische Verwarmings
Onderneming
Rotterdam

31

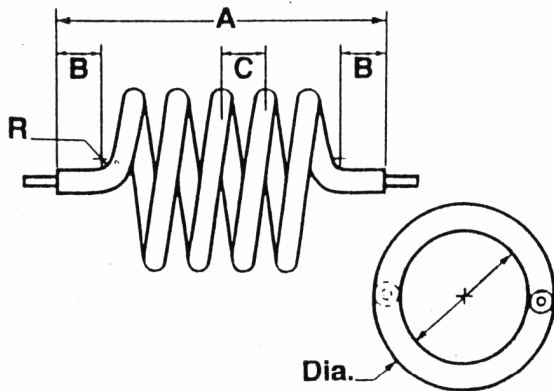

34

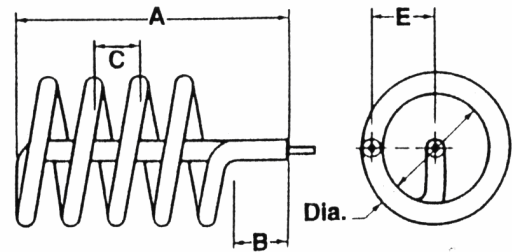

32

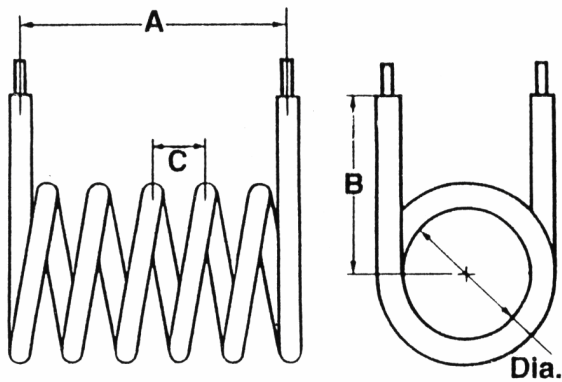

35

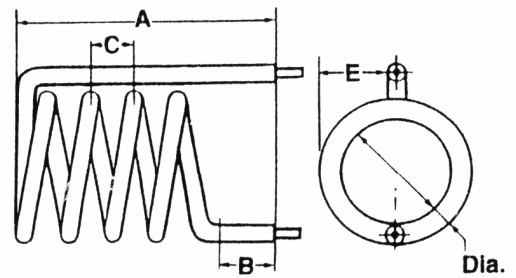

33

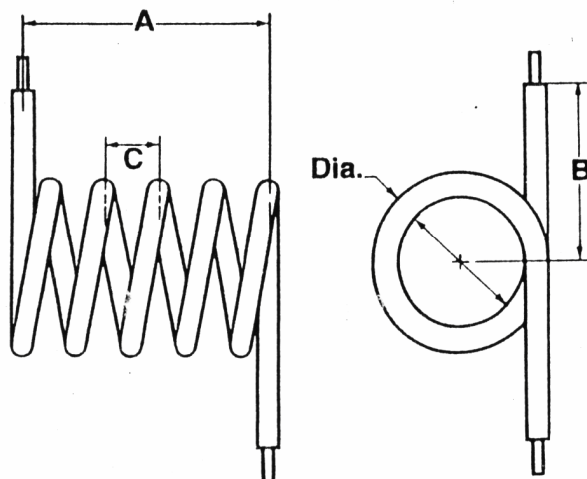

36

